

Interior side

Exterior side

Insulated Laminated glass

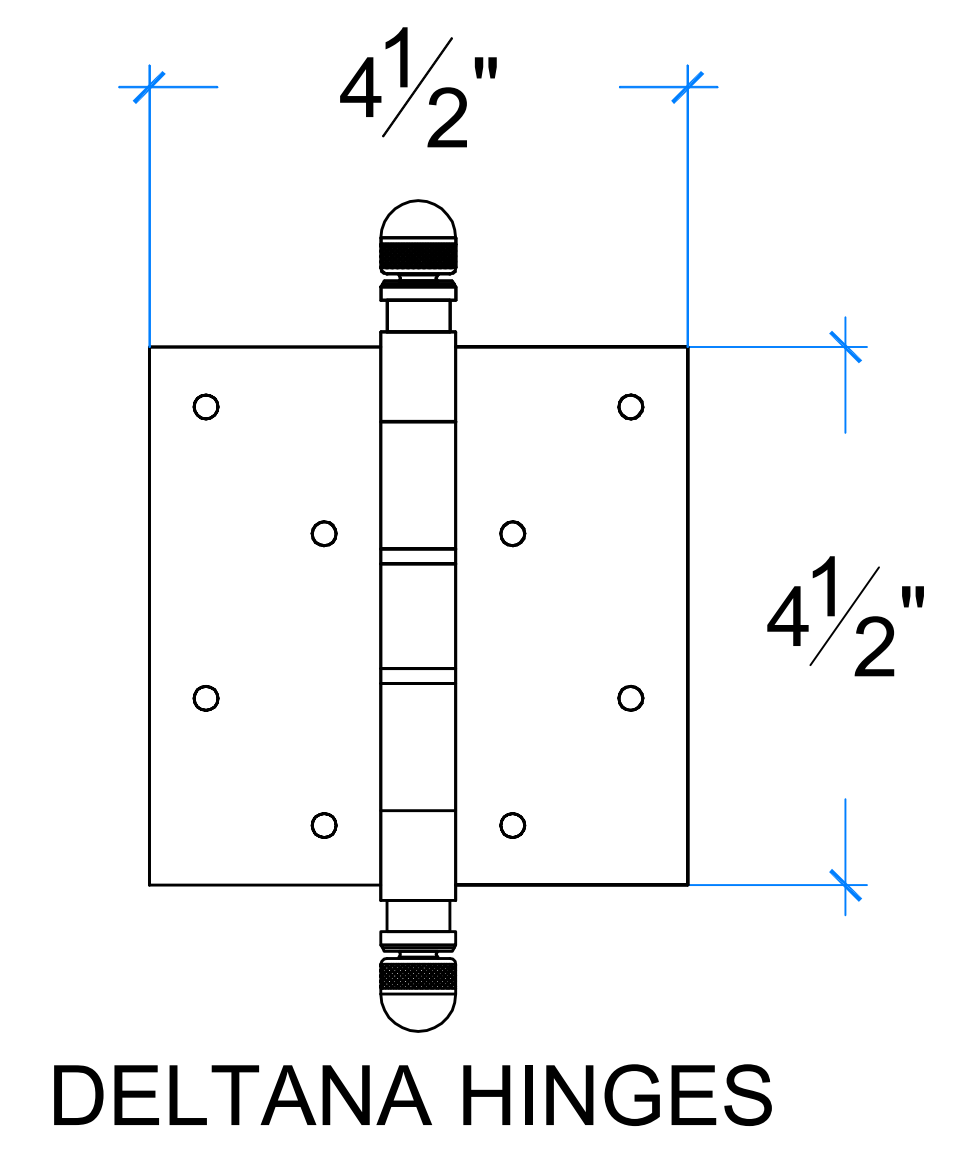
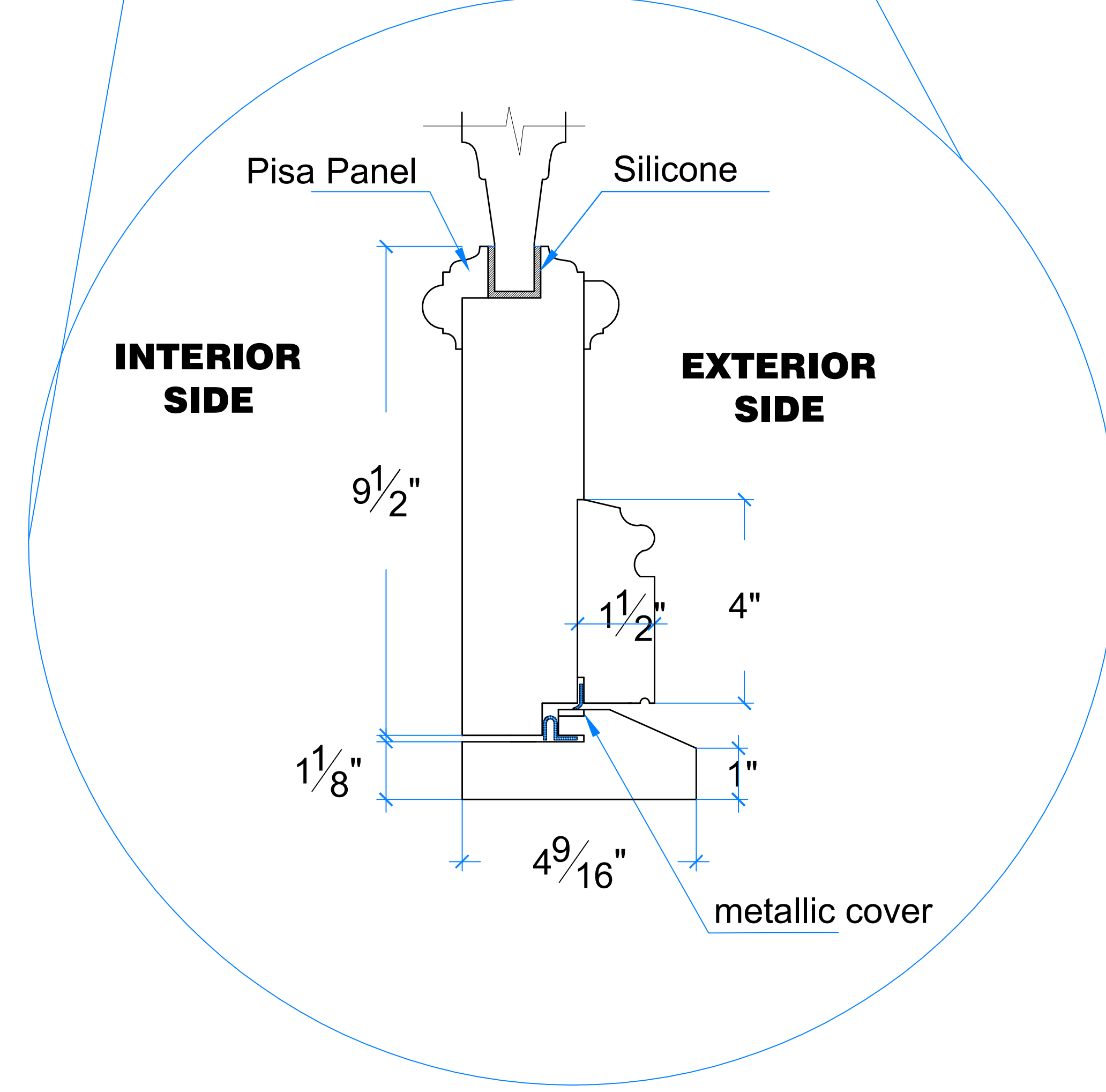
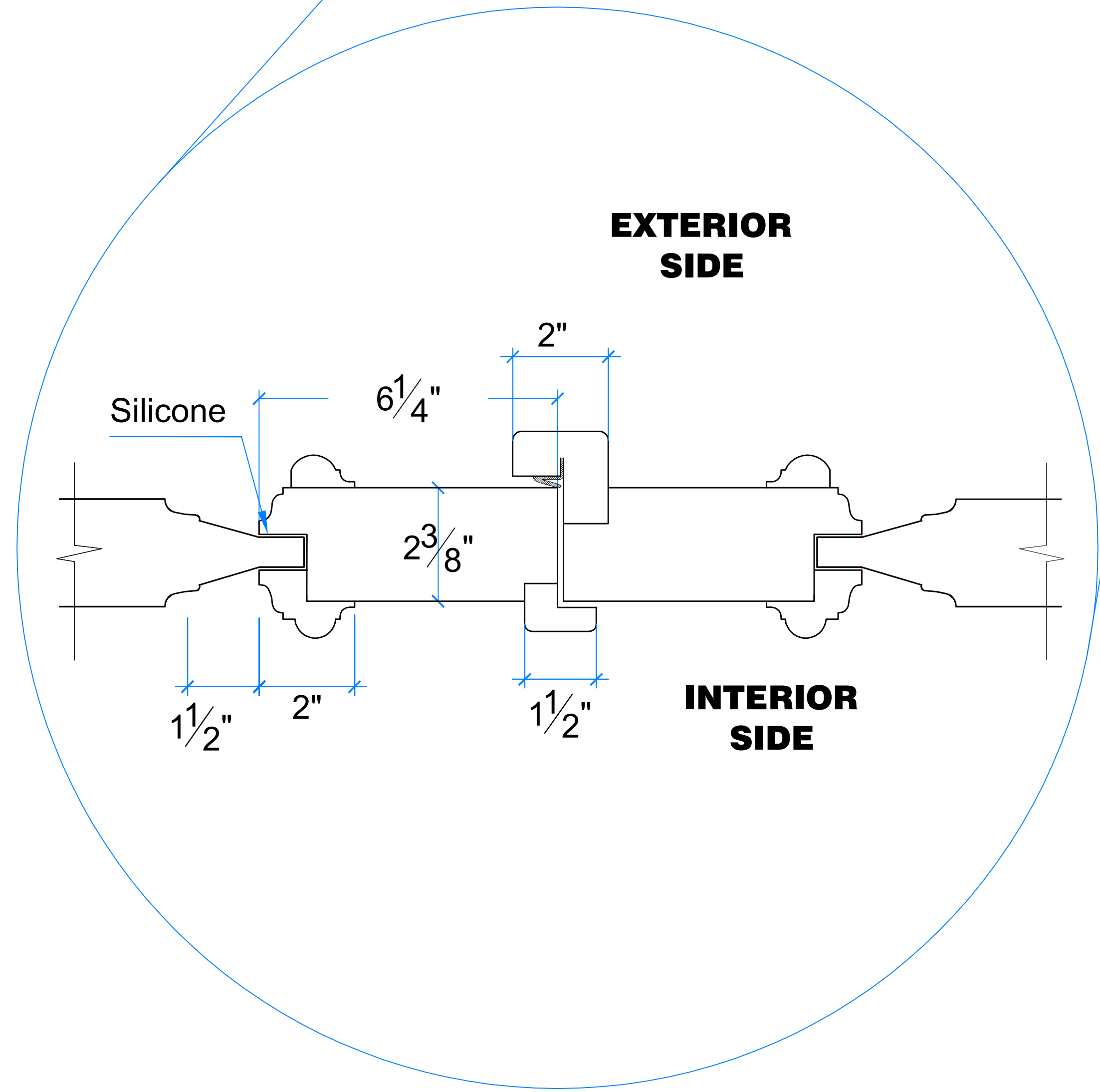
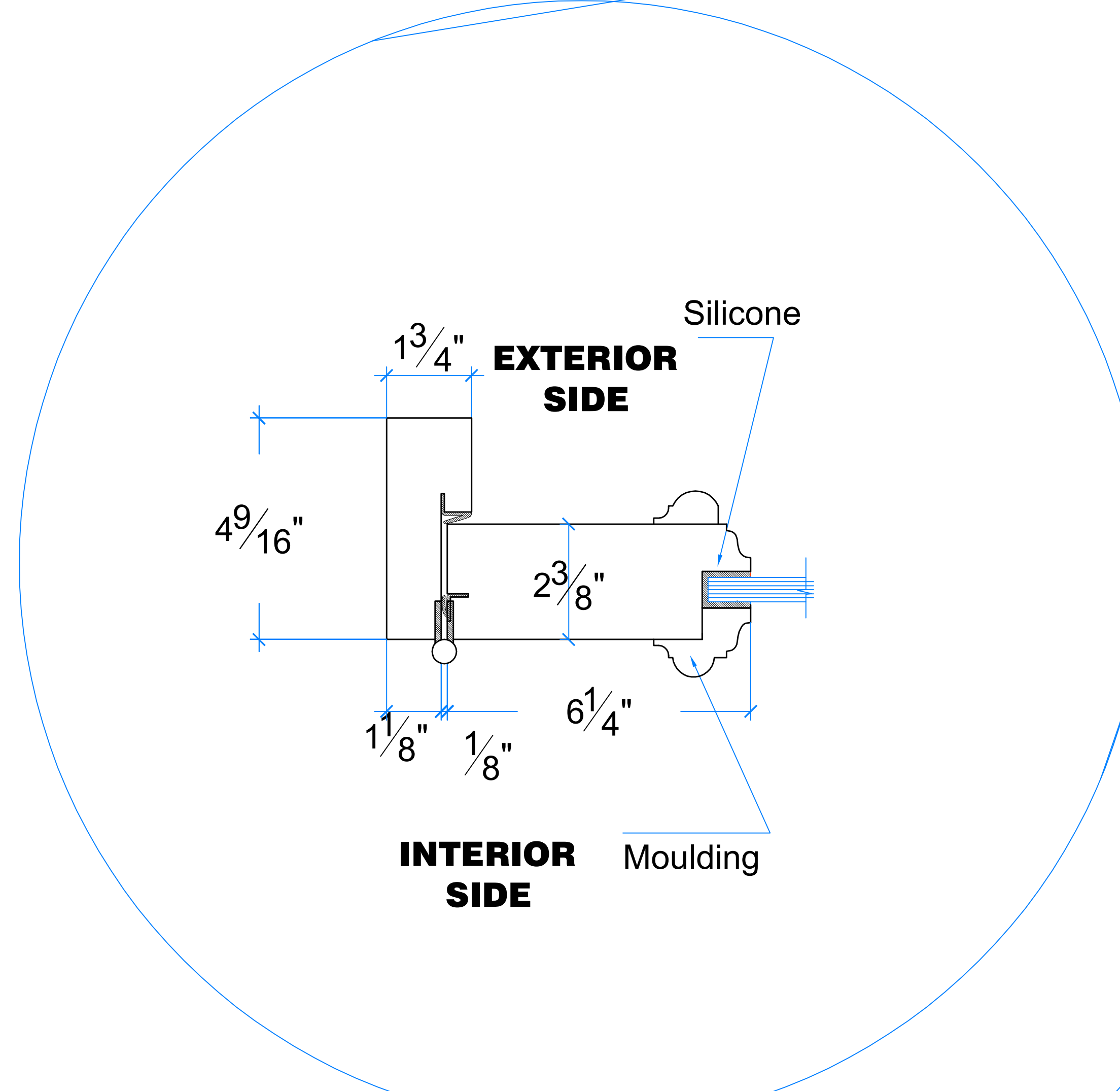
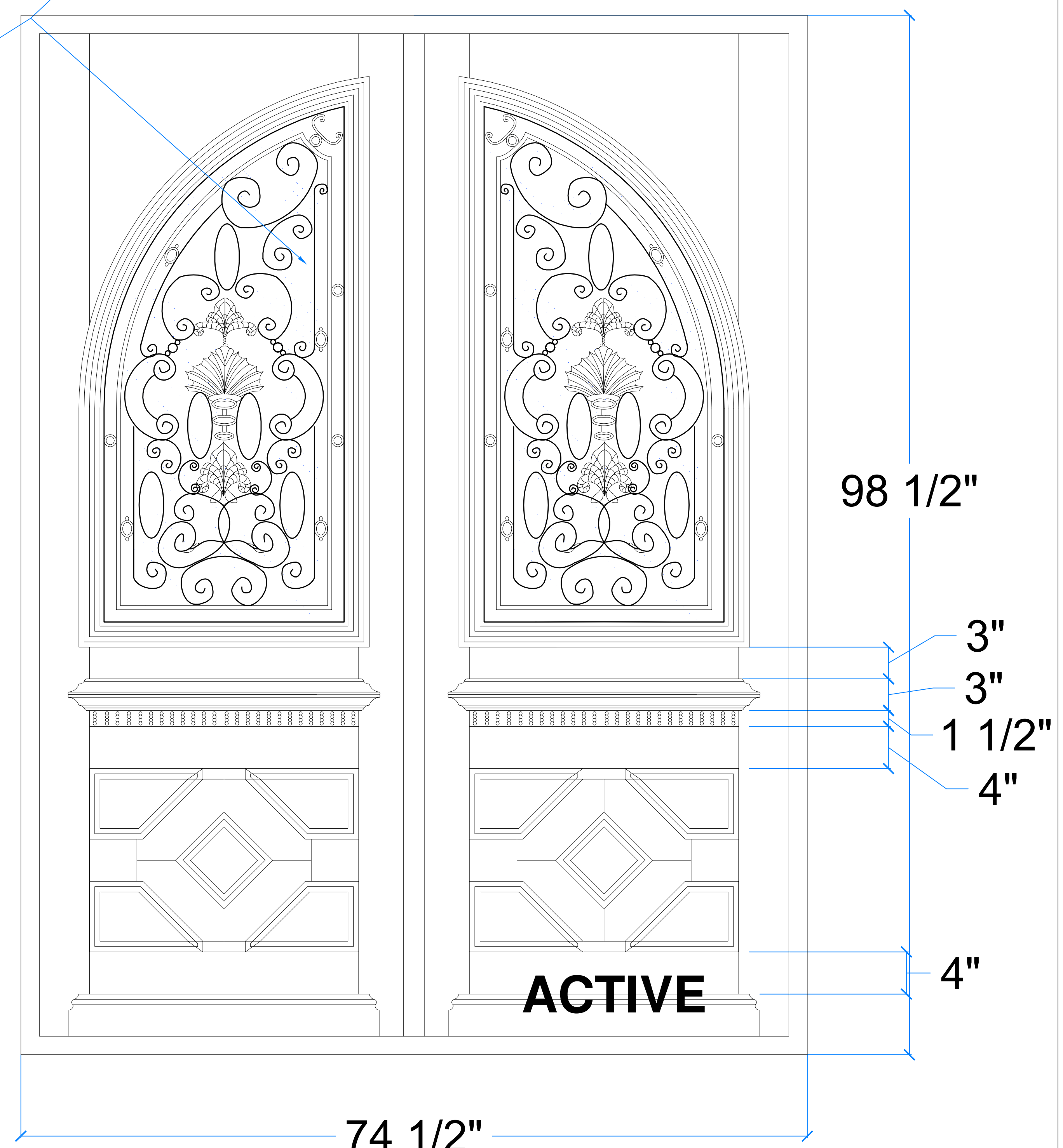
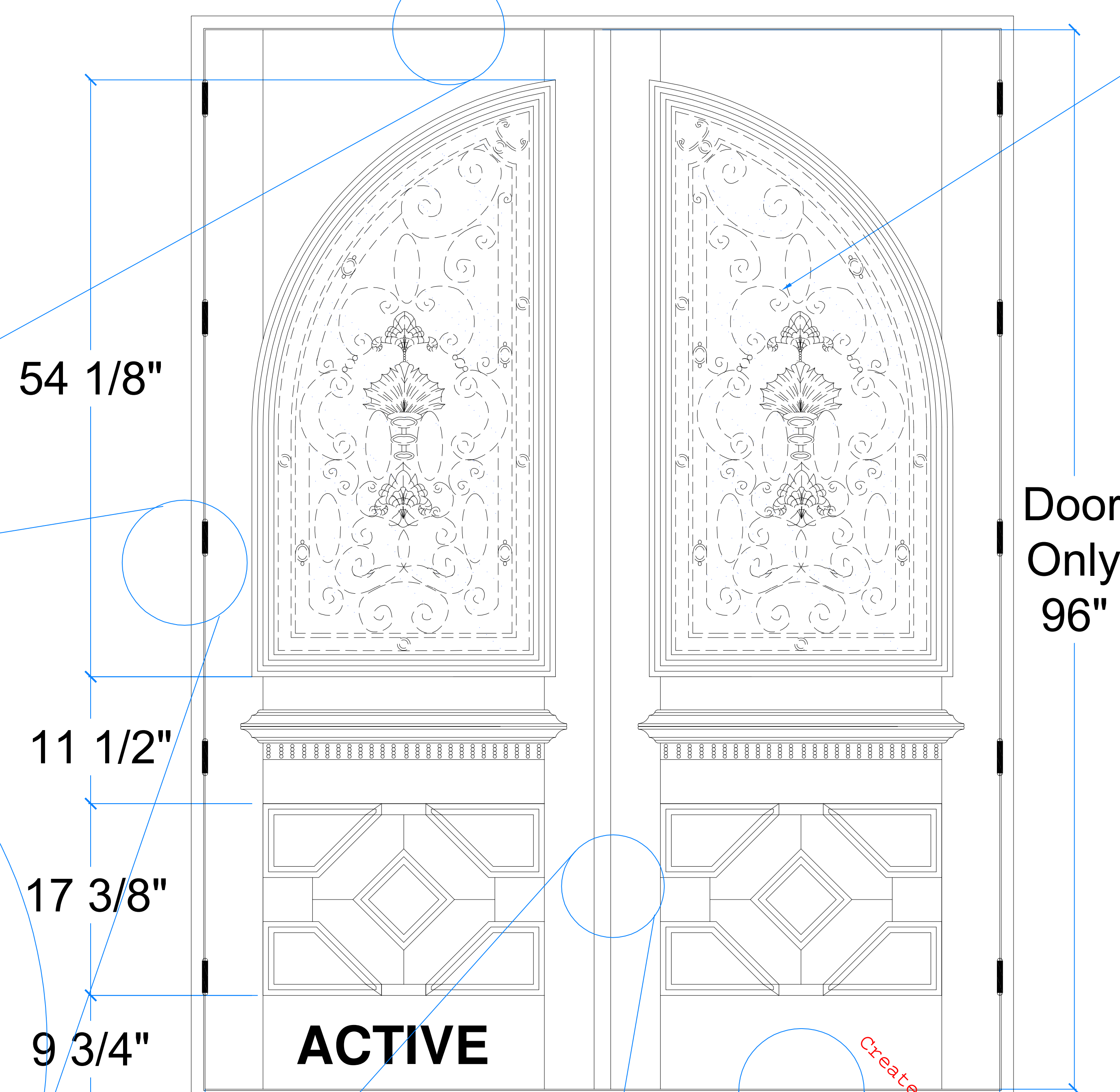
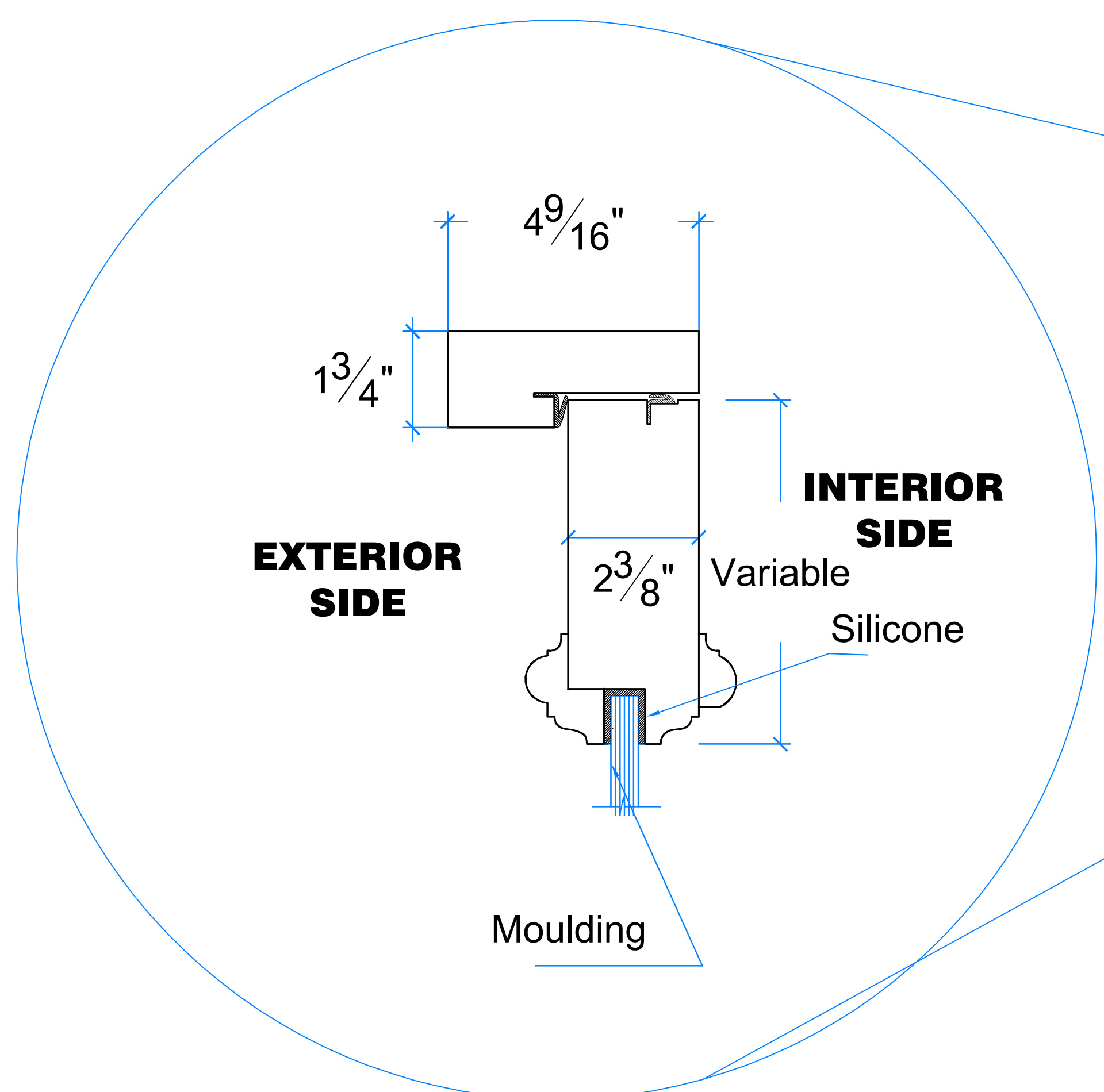

Created by Acroploc Evaluation Version.

Client: **Fran Stephen**

Client signature:

Specs:

Scale: **No Scale**

Sheet: **01 of 01**